



## Lifting force tables EZ28

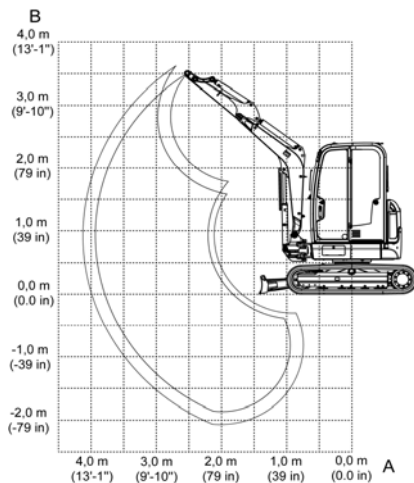

Fig. 1: Lifting force table EZ28

Designation	Explanation
A	Outreach from middle of rotating assembly
B	Load hook height
max	Permissible weight or mass value with extended arm system
	With or without dozer blade support in travel direction
	With or without dozer blade support 90° from the travel direction
	Dozer blade down
	Dozer blade up

All table values are specified in kg (lbs.), in a horizontal position on firm even ground as well as without a bucket or an attachment (e.g. breaker, etc.).

The lifting force of the vehicle is limited by the hydraulic capacity or by the tilting safety mechanism.

Neither 75% of the static tipping load nor 87% of the hydraulic lifting force are exceeded.

Base of calculation: according to ISO 10567. Set pressure at the lifting arm cylinder: 22500 kPa (3263 psi)











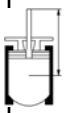

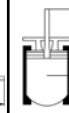
The lifting capability applies for vehicles under the following conditions:

- Lubricants and operating materials at the prescribed levels.
- Full fuel tank.
- Cabin or canopy.
- Vehicle at operating temperature.
- Weight of the operator 75 kg (165 lbs.).



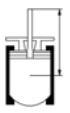
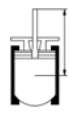



**WACKER  
NEUSON**  
*all it takes!*

**Lifting force tables EZ28**

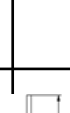
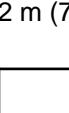
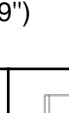
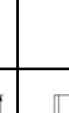
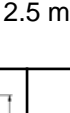
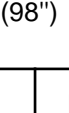
A B	2 m (79")			2.5 m (98")			3 m (9'-10")			3.5 m (11'-6")					
															
3.0 m (9.8 ft.)	-	-	-	-	-	-	505 (1,113)	402 (886)	450 (992)	-	-	-	521 (1,150)	365 (804)	408 (901)
2.0 m (6.6 ft.)	-	-	-	603 (1,329)	528 (1,165)	597 (1,317)	538 (1,187)	390 (860)	438 (965)	505 (1,113)	299 (660)	335 (739)	502 (1,107)	261 (576)	293 (646)
1.0 m (3.3 ft.)	-	-	-	895 (1,973)	464 (1,023)	530 (1,168)	681 (1,501)	356 (784)	402 (886)	569 (1,255)	281 (620)	316 (698)	507 (1,118)	231 (510)	260 (574)
0.0 m (0.0 ft.)	139 8 (3,083)	608 (1,342)	712 (1,569)	992 (2,188)	432 (952)	496 (1,093)	750 (1,654)	333 (733)	378 (833)	597 (1,316)	267 (589)	302 (666)	517 (1,141)	239 (526)	269 (593)
-1.0 m (-3.3 ft.)	110 5 (2,437)	622 (1,371)	726 (1,600)	826 (1,822)	436 (961)	500 (1,103)	622 (1,371)	335 (739)	381 (839)	-	-	-	512 (1,128)	302 (666)	342 (753)

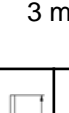
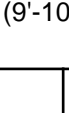
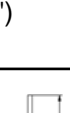
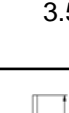
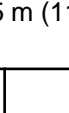
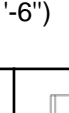
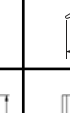
Tab. 1: Lifting force tables EZ28 – Canopy and short dipper stick











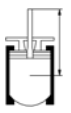

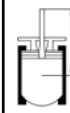
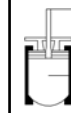









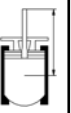

A B	2 m (79")			2.5 m (98")			3 m (9'-10")			3.5 m (11'-6")					
															
3.0 m (9.8 ft.)	-	-	-	-	-	-	434 (957)	407 (899)	434 (957)	-	-	-	470 (1,035)	318 (701)	356 (786)
2.0 m (6.6 ft.)	-	-	-	-	-	-	486 (1,071)	393 (866)	441 (972)	462 (1,019)	300 (661)	336 (741)	459 (1,012)	236 (521)	265 (585)
1.0 m (3.3 ft.)	-	-	-	832 (1,835)	468 (1,033)	535 (1,179)	641 (1,414)	356 (784)	402 (887)	541 (1,192)	279 (615)	314 (693)	466 (1,027)	210 (463)	237 (522)
0.0 m (0.0 ft.)	143 6 (3,167)	599 (1,321)	702 (1,549)	985 (2,172)	427 (941)	491 (1,082)	739 (1,630)	328 (723)	373 (823)	591 (1,303)	262 (577)	297 (654)	478 (1,054)	215 (475)	243 (537)
-1.0 m (-3.3 ft.)	119 9 (2,645)	606 (1,337)	710 (1,566)	875 (1,930)	425 (936)	488 (1,077)	664 (1,464)	324 (715)	370 (815)	-	-	-	482 (1,062)	264 (582)	299 (659)

Tab. 2: Lifting force tables EZ28 – Canopy and long dipper stick











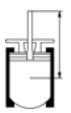

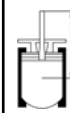
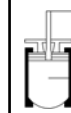









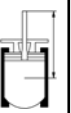



**WACKER  
NEUSON**  
*all it takes!*

**Lifting force tables EZ28**

A B	2 m (79")			2.5 m (98")			3 m (9'-10")			3.5 m (11'-6")					
															
															
3.0 m (9.8 ft.)	-	-	-	-	-	-	505 (1,113)	457 (1,008)	505 (1,114)	-	-	-	521 (1,150)	417 (919)	466 (1,028)
2.0 m (6.6 ft.)	-	-	-	603 (1,329)	599 (1,321)	603 (1,330)	538 (1,187)	445 (982)	499 (1,101)	505 (1,113)	345 (760)	385 (849)	502 (1,107)	303 (668)	339 (747)
1.0 m (3.3 ft.)	-	-	-	895 (1,973)	535 (1,179)	609 (1,343)	681 (1,501)	411 (906)	463 (1,022)	569 (1,255)	327 (720)	367 (808)	507 (1,118)	271 (597)	303 (669)
0.0 m (0.0 ft.)	1398 (3,083)	706 (1,556)	823 (1,815)	992 (2,188)	503 (1,108)	575 (1,268)	750 (1,654)	388 (856)	439 (969)	597 (1,316)	313 (690)	352 (777)	517 (1,141)	280 (617)	314 (693)
-1.0 m (-3.3 ft.)	1105 (2,437)	719 (1,585)	837 (1,846)	826 (1,822)	507 (1,117)	579 (1,277)	622 (1,371)	391 (861)	442 (975)	-	-	-	512 (1,128)	352 (776)	397 (875)

Tab. 3: Lifting force tables EZ28 – Canopy, short dipper stick and rear weight



























A B	2 m (79")			2.5 m (98")			3 m (9'-10")			3.5 m (11'-6")					
															
															
3.0 m (9.8 ft.)	-	-	-	-	-	-	434 (957)	434 (957)	434 (957)	-	-	-	470 (1,035)	365 (806)	408 (900)
2.0 m (6.6 ft.)	-	-	-	-	-	-	486 (1,071)	448 (988)	486 (1,072)	462 (1,019)	345 (761)	386 (851)	459 (1,012)	275 (607)	308 (679)
1.0 m (3.3 ft.)	-	-	-	832 (1,835)	539 (1,188)	614 (1,354)	641 (1,414)	411 (906)	464 (1,022)	541 (1,192)	325 (716)	365 (804)	466 (1,027)	247 (545)	278 (612)
0.0 m (0.0 ft.)	1436 (3,167)	697 (1,536)	814 (1,795)	985 (2,172)	497 (1,097)	570 (1,257)	739 (1,630)	383 (845)	435 (958)	591 (1,303)	307 (677)	347 (765)	478 (1,054)	254 (560)	286 (630)
-1.0 m (-3.3 ft.)	1199 (2,645)	704 (1,552)	822 (1,812)	875 (1,930)	495 (1,092)	568 (1,252)	664 (1,464)	380 (837)	431 (951)	-	-	-	482 (1,062)	310 (683)	349 (770)

Tab. 4: Lifting force tables EZ28 – Canopy, long dipper stick and rear weight











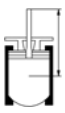















**WACKER  
NEUSON**  
*all it takes!*

**Lifting force tables EZ28**

A B	2 m (79")			2.5 m (98")			3 m (9'-10")			3.5 m (11'-6")					
															
															
3.0 m (9.8 ft.)	-	-	-	-	-	-	505 (1,113)	420 (926)	473 (1,042)	-	-	-	521 (1,150)	382 (843)	430 (948)
2.0 m (6.6 ft.)	-	-	-	603 (1,329)	552 (1,217)	603 (1,330)	538 (1,187)	409 (901)	461 (1,016)	505 (1,113)	314 (693)	354 (780)	502 (1,107)	275 (607)	310 (684)
1.0 m (3.3 ft.)	-	-	-	895 (1,973)	488 (1,075)	559 (1,233)	681 (1,501)	374 (825)	425 (937)	569 (1,255)	296 (654)	335 (739)	507 (1,118)	244 (539)	276 (609)
0.0 m (0.0 ft.)	1398 (3,083)	641 (1,413)	753 (1,661)	992 (2,188)	456 (1,005)	525 (1,158)	750 (1,654)	351 (774)	401 (884)	597 (1,316)	283 (623)	321 (707)	517 (1,141)	252 (556)	286 (630)
-1.0 m (-3.3 ft.)	1105 (2,437)	654 (1,442)	767 (1,692)	826 (1,822)	460 (1,013)	529 (1,167)	622 (1,371)	354 (780)	403 (890)	-	-	-	512 (1,128)	319 (703)	362 (798)

Tab. 5: Lifting force tables EZ28 – Cabin and short dipper stick











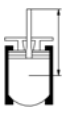

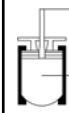
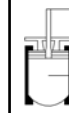









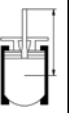

A B	2 m (79")			2.5 m (98")			3 m (9'-10")			3.5 m (11'-6")					
															
															
3.0 m (9.8 ft.)	-	-	-	-	-	-	434 (957)	426 (939)	434 (957)	-	-	-	470 (1,035)	334 (736)	376 (828)
2.0 m (6.6 ft.)	-	-	-	-	-	-	486 (1,071)	411 (906)	464 (1,022)	462 (1,019)	315 (695)	355 (782)	459 (1,012)	249 (550)	281 (620)
1.0 m (3.3 ft.)	-	-	-	832 (1,835)	492 (1,085)	564 (1,244)	641 (1,414)	374 (825)	425 (937)	541 (1,192)	294 (649)	333 (735)	466 (1,027)	223 (491)	252 (556)
0.0 m (0.0 ft.)	1436 (3,167)	632 (1,393)	744 (1,640)	985 (2,172)	450 (993)	520 (1,147)	739 (1,630)	346 (763)	396 (873)	591 (1,303)	277 (611)	315 (695)	478 (1,054)	228 (503)	259 (571)
-1.0 m (-3.3 ft.)	1199 (2,645)	639 (1,409)	751 (1,657)	875 (1,930)	448 (988)	518 (1,142)	664 (1,464)	343 (756)	393 (866)	-	-	-	482 (1,062)	279 (616)	318 (700)

Tab. 6: Lifting force tables EZ28 – Cabin and long dipper stick















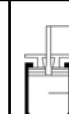



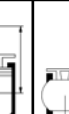

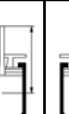







**WACKER  
NEUSON**  
*all it takes!*

**Lifting force tables EZ28**

A B	2 m (79")			2.5 m (98")			3 m (9'-10")			3.5 m (11'-6")					
															
															
3.0 m (9.8 ft.)	-	-	-	-	-	-	505 (1,113)	476 (1,049)	505 (1,114)	-	-	-	521 (1,150)	434 (957)	487 (1,075)
2.0 m (6.6 ft.)	-	-	-	603 (1,329)	603 (1,330)	603 (1,330)	538 (1,187)	464 (1,023)	522 (1,151)	505 (1,113)	360 (794)	404 (890)	502 (1,107)	317 (699)	356 (785)
1.0 m (3.3 ft.)	-	-	-	895 (1,973)	558 (1,231)	638 (1,408)	681 (1,501)	430 (947)	486 (1,072)	569 (1,255)	342 (754)	385 (849)	507 (1,118)	284 (626)	319 (704)
0.0 m (0.0 ft.)	1398 (3,083)	738 (1,628)	865 (1,907)	992 (2,188)	526 (1,160)	604 (1,333)	750 (1,654)	407 (896)	462 (1,019)	597 (1,316)	328 (724)	371 (818)	517 (1,141)	294 (647)	331 (730)
-1.0 m (-3.3 ft.)	1105 (2,437)	751 (1,657)	879 (1,938)	826 (1,822)	530 (1,169)	609 (1,342)	622 (1,371)	409 (902)	465 (1,025)	-	-	-	512 (1,128)	369 (813)	417 (920)

Tab. 7: Lifting force tables EZ28 – Cabin, short dipper stick and rear weight













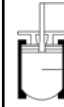





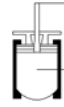
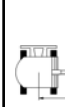

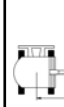

A B	2 m (79")			2.5 m (98")			3 m (9'-10")			3.5 m (11'-6")					
															
															
3.0 m (9.8 ft.)	-	-	-	-	-	-	434 (957)	434 (957)	434 (957)	-	-	-	470 (1,035)	381 (840)	428 (943)
2.0 m (6.6 ft.)	-	-	-	-	-	-	486 (1,071)	466 (1,029)	486 (1,072)	462 (1,019)	361 (795)	405 (892)	459 (1,012)	288 (636)	324 (715)
1.0 m (3.3 ft.)	-	-	-	832 (1,835)	563 (1,241)	643 (1,418)	641 (1,414)	429 (947)	486 (1,073)	541 (1,192)	340 (749)	383 (845)	466 (1,027)	260 (573)	293 (645)
0.0 m (0.0 ft.)	1436 (3,167)	729 (1,608)	855 (1,886)	985 (2,172)	521 (1,149)	599 (1,322)	739 (1,630)	402 (886)	457 (1,009)	591 (1,303)	322 (711)	365 (806)	478 (1,054)	267 (588)	301 (665)
-1.0 m (-3.3 ft.)	1199 (2,645)	736 (1,624)	863 (1,903)	875 (1,930)	519 (1,144)	597 (1,317)	664 (1,464)	398 (878)	454 (1,001)	-	-	-	482 (1,062)	325 (716)	368 (811)

Tab. 8: Lifting force tables EZ28 – Cabin, long dipper stick and rear weight















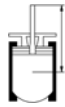

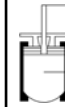



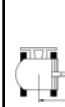

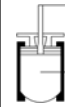
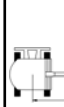



**WACKER  
NEUSON**  
*all it takes!*

**Lifting force tables EZ28**

A B	2 m (79")			2.5 m (98")			3 m (9'-10")			3.5 m (11'-6")					
															
															
3.0 m (9.8 ft.)	-	-	-	-	-	-	495 (1,093)	464 (1,022)	495 (1,091)	-	-	-	516 (1,137)	403 (889)	444 (978)
2.0 m (6.6 ft.)	-	-	-	628 (1,385)	599 (1,322)	628 (1,385)	549 (1,212)	448 (987)	494 (1,090)	508 (1,121)	348 (767)	382 (843)	501 (1,105)	303 (667)	333 (733)
1.0 m (3.3 ft.)	-	-	-	912 (2,010)	536 (1,181)	601 (1,325)	690 (1,522)	413 (910)	458 (1,010)	573 (1,264)	329 (726)	363 (801)	507 (1,119)	275 (606)	303 (667)
0.0 m (0.0 ft.)	1366 (3,013)	715 (1,578)	821 (1,809)	979 (2,159)	509 (1,121)	572 (1,261)	743 (1,638)	392 (865)	437 (963)	589 (1,299)	317 (699)	351 (773)	517 (1,141)	289 (637)	319 (703)
-1.0 m (-3.3 ft.)	1044 (2,302)	731 (1,612)	838 (1,847)	783 (1,727)	516 (1,137)	580 (1,278)	579 (1,276)	399 (879)	444 (978)	-	-	-	506 (1,116)	375 (827)	416 (917)

Tab. 9: Lifting force tables EZ28 – Cabin, short dipper stick and vertical digging system (VDS)













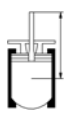

A B	2 m (79")			2.5 m (98")			3 m (9'-10")			3.5 m (11'-6")					
															
															
3.0 m (9.8 ft.)	-	-	-	-	-	-	430 (948)	430 (948)	430 (948)	-	-	-	466 (1,027)	356 (785)	391 (863)
2.0 m (6.6 ft.)	-	-	-	-	-	-	498 (1,098)	450 (992)	497 (1,096)	468 (1,031)	348 (767)	383 (845)	458 (1,011)	275 (607)	303 (668)
1.0 m (3.3 ft.)	-	-	-	855 (1,885)	539 (1,189)	605 (1,333)	654 (1,441)	412 (909)	458 (1,010)	547 (1,206)	327 (720)	361 (796)	466 (1,028)	251 (553)	277 (610)
0.0 m (0.0 ft.)	1410 (3,109)	705 (1,555)	810 (1,787)	977 (2,155)	503 (1,108)	566 (1,249)	736 (1,623)	387 (853)	431 (951)	587 (1,295)	311 (685)	344 (760)	478 (1,055)	262 (577)	289 (638)
-1.0 m (-3.3 ft.)	1145 (2,524)	715 (1,578)	821 (1,811)	840 (1,851)	504 (1,110)	567 (1,251)	635 (1,399)	387 (853)	431 (951)	-	-	-	479 (1,055)	328 (722)	363 (801)

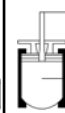
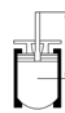
Tab. 10: Lifting force tables EZ28 – Cabin, long dipper stick and vertical digging system (VDS)



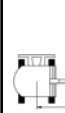

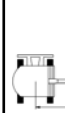













**WACKER  
NEUSON**  
*all it takes!*

**Lifting force tables EZ28**

A B	2 m (79")			2.5 m (98")			3 m (9'-10")			3.5 m (11'-6")					
															
3.0 m (9.8 ft.)	-	-	-	-	-	-	495	495	495	-	-	-	516	454	497
	-	-	-	-	-	-	(1,093)	(1,091)	(1,091)	-	-	-	(1,137)	(1,002)	(1,096)
2.0 m (6.6 ft.)	-	-	-	628	628	628	549	504	549	508	394	431	501	345	376
	-	-	-	(1,385)	(1,385)	(1,385)	(1,212)	(1,112)	(1,211)	(1,121)	(869)	(949)	(1,105)	(760)	(829)
1.0 m (3.3 ft.)	-	-	-	912	608	677	690	469	517	573	376	411	507	315	344
	-	-	-	(2,010)	(1,340)	(1,492)	(1,522)	(1,035)	(1,140)	(1,264)	(828)	(907)	(1,119)	(695)	(758)
0.0 m (0.0 ft.)	1366	815	927	979	581	648	743	449	496	589	363	399	517	331	363
	(3,013)	(1,797)	(2,045)	(2,159)	(1,280)	(1,429)	(1,638)	(990)	(1,093)	(1,299)	(801)	(879)	(1,141)	(731)	(800)
-1.0 m (-3.3 ft.)	1044	830	944	783	588	656	579	455	502	-	-	-	506	428	471
	(2,302)	(1,831)	(2,082)	(1,727)	(1,296)	(1,446)	(1,276)	(1,004)	(1,108)	-	-	-	(1,116)	(944)	(1,039)

Tab. 11: Lifting force tables EZ28 – Cabin, short dipper stick, rear weight and vertical digging system (VDS)

A B	2 m (79")			2.5 m (98")			3 m (9'-10")			3.5 m (11'-6")					
															
3.0 m (9.8 ft.)	-	-	-	-	-	-	430	430	430	-	-	-	466	403	440
	-	-	-	-	-	-	(948)	(948)	(948)	-	-	-	(1,027)	(888)	(970)
2.0 m (6.6 ft.)	-	-	-	-	-	-	498	498	498	468	394	431	458	315	344
	-	-	-	-	-	-	(1,098)	(1,098)	(1,098)	(1,031)	(870)	(951)	(1,011)	(694)	(757)
1.0 m (3.3 ft.)	-	-	-	855	611	681	654	469	517	547	373	409	466	289	316
	-	-	-	(1,885)	(1,347)	(1,501)	(1,441)	(1,034)	(1,139)	(1,206)	(823)	(902)	(1,028)	(637)	(696)
0.0 m (0.0 ft.)	1410	805	917	977	575	642	736	443	490	587	357	393	478	302	330
	(3,109)	(1,774)	(2,022)	(2,155)	(1,267)	(1,416)	(1,623)	(978)	(1,081)	(1,295)	(788)	(866)	(1,055)	(665)	(728)
-1.0 m (-3.3 ft.)	1145	815	928	840	576	643	635	443	490	-	-	-	479	376	413
	(2,524)	(1,797)	(2,046)	(1,851)	(1,269)	(1,418)	(1,399)	(977)	(1,081)	-	-	-	(1,055)	(828)	(911)

Tab. 12: Lifting force tables EZ28 – Cabin, long dipper stick, rear weight and vertical digging system (VDS)